



### **Installation Instructions for the 4004 Street Light Package**

1. *Warning:* Before attempting to install units, please ensure power to the outlet box is off.
2. Carefully unpack and identify all parts, referring to the parts list included with your package.
3. Use four bolts, four nuts, and four washers to install the base into the ground.
4. Install the post onto the base.
5. Firmly attach the outlet wire from the lamp fixture to the main power supply.
6. Attach the fixture to the pole.
7. Install light bulb.
  - a. Note: the bulb must not exceed wattage specified on fixture label.
8. Replace lamp access cover or lamp glass cover, using the screws provided.
9. Turn on the power.

***Disclaimer:*** All electrical connections must be in accordance with local codes or the national electrical code. If you are unfamiliar with the installation method and the connection of electrical wire, please contact a qualified, licensed electrician to assist you.

**View installation diagram on next page.**

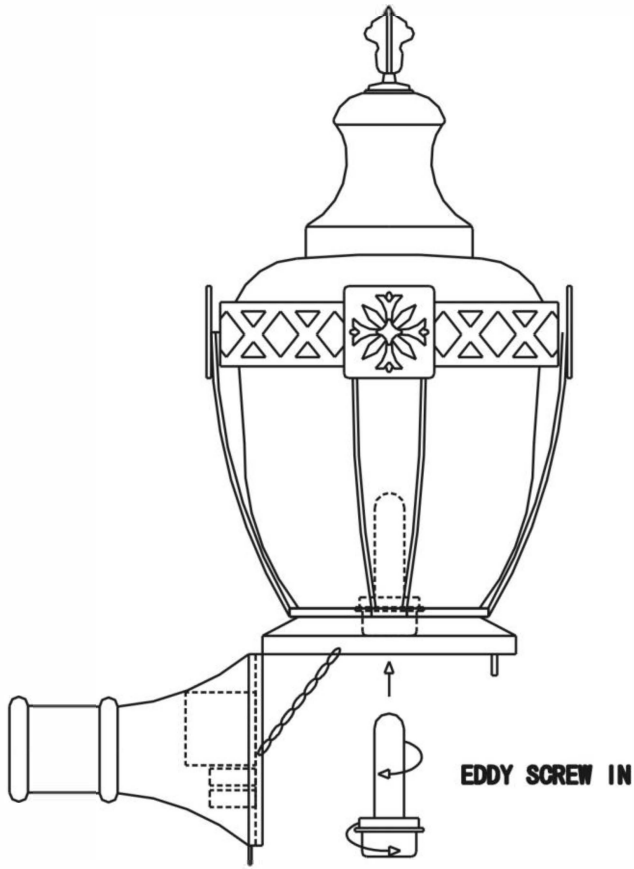

FIG. 1

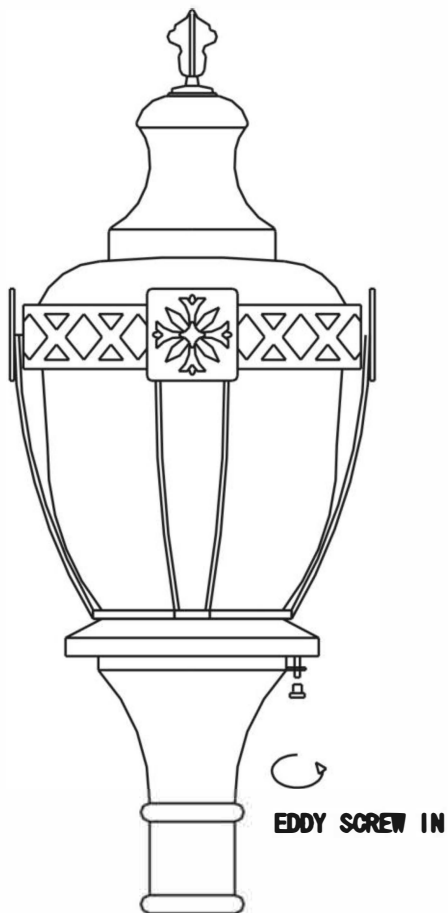

FIG. 2



EDDY SCREW IN



EDDY SCREW IN

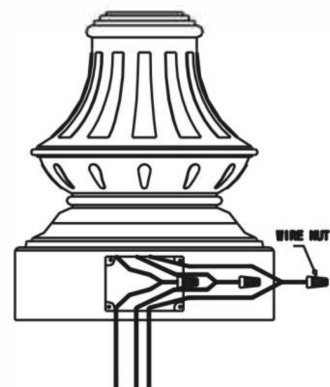
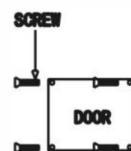

FIG. 3